

RICOH

FAX2050L

Operating Instructions <Basic Features>

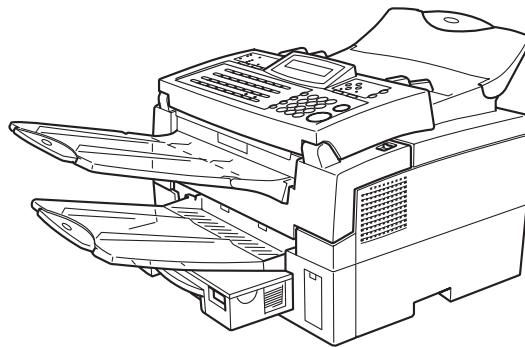

ZDRH010N

Read this manual carefully before you use this product and keep it handy for future reference.
For safety, please follow the instructions in this manual.



RICOH COMPANY, LTD.

15-5, Minami Aoyama 1-chome,
Minato-ku, Tokyo 107-8544, Japan
Phone: +81-(0)3-3479-3111

Ricoh shall not be responsible for any damage or expense that may result from the use of parts other than recommended parts.

For good copy quality, Ricoh recommends that you use genuine Ricoh toner.

TONER CASSETTES

RICOH FAX TONER CASSETTE TYPE 1435 BLACK is recommended for the best performance.

Overseas Affiliates

U.S.A.

RICOH CORPORATION
5 Dedrick Place
West Caldwell, New Jersey 07006
Phone: +1-973-882-2000

The Netherlands

RICOH EUROPE B.V.
Groenelaan 3, 1186 AA, Amstelveen
Phone: +31-(0)20-5474111

United Kingdom

RICOH UK LTD.
Ricoh House,
1 Plane Tree Crescent, Feltham,
Middlesex, TW13 7HG
Phone: +44-(0)20-8261-4000

Germany

RICOH DEUTSCHLAND GmbH
Mergenthalerallee 38-40,
65760 Eschborn
Phone: +49-(0)6196-9060

France

RICOH FRANCE S.A.
383, Avenue du Général de Gaulle
BP 307-92143 Clamart Cedex
Phone: +33-(0)1-40-94-38-38

Spain

RICOH ESPAÑA S.A.
Avda. Litoral Mar, 12-14,
08005 Barcelona
Phone: +34-(0)93-295-7600

Italy

RICOH ITALIA SpA
Via della Metallurgia 12,
37139 Verona
Phone: +39-045-8181500

Hong Kong

RICOH HONG KONG LTD.
21/F., Tai Yau Building,
181, Johnston Road,
Wan Chai, Hong Kong
Phone: +852-2862-2888

Singapore

RICOH ASIA PACIFIC PTE.LTD.
260 Orchard Road,
#15-01/02 The Heeren,
Singapore 238855
Phone: +65-830-5888

FAX2050L Operating Instructions

Introduction

This manual contains detailed instructions on the operation and maintenance of this machine. To get maximum versatility from this machine all operators should carefully read and follow the instructions in this manual. Please keep this manual in a handy place near the machine.

Please read the Safety Information in the Advanced Features manual before using this machine. It contains important information related to USER SAFETY and PREVENTING EQUIPMENT PROBLEMS.

Notes:

Some illustrations might be slightly different from your machine.

Certain options might not be available in some countries. For details, please contact your local dealer.

Laser Safety:

The Center for Devices and Radiological Health (CDRH) prohibits the repair of laser-based optical unit in the field. The optical housing unit can only be repaired in a factory or at a location with the requisite equipment. The laser subsystem is replaceable in the field by a qualified Customer Engineer. The laser chassis is not repairable in the field. Customer engineers are therefore directed to return all chassis and laser subsystems to the factory or service depot when replacement or the optical subsystem is required.

Warning:

Use of controls or adjustment or performance of procedures other than those specified in this manual might result in hazardous radiation exposure.

Two kinds of size notation are employed in this manual. With this machine refer to the inch version.

For good copy quality, Ricoh recommends that you use genuine Ricoh toner.

Ricoh shall not be responsible for any damage or expense that might result from the use of parts other than genuine Ricoh parts in your Ricoh office product.

Important

Parts of this manual are subject to change without prior notice. In no event will the company be liable for direct, indirect, special, incidental, or consequential damages as a result of handling or operating the machine.

Power Source:

115V, 60Hz

Please be sure to connect the power cord to a power source as above. For details about power source, see Chapter 10, "Connecting the Power and Switching On" in the Advanced Features manual.

Declaration of Conformity

Product Name: Facsimile

Model Number: FAX2050L

Responsible party: Ricoh Corporation

Address: 5 Dedrick Place, West Caldwell, NJ 07006

Telephone number: 973-882-2000

This device complies with part 15 of FCC Rules.

Operation is subject to the following two conditions:

1. This device may not cause harmful interference, and
2. this device must accept any interference received, including interference that may cause undesired operation.

Introduction

This manual contains detailed instructions on the operation and maintenance of this machine. To get maximum versatility from this machine all operators should carefully read and follow the instructions in this manual. Please keep this manual in a handy place near the machine.

Please read the Safety Information in the Advanced Features manual before using this machine. It contains important information related to USER SAFETY and PREVENTING EQUIPMENT PROBLEMS.

Notes:

Some illustrations might be slightly different from your machine.

Certain options might not be available in some countries. For details, please contact your local dealer.

Laser Safety:

The Center for Devices and Radiological Health (CDRH) prohibits the repair of laser-based optical unit in the field. The optical housing unit can only be repaired in a factory or at a location with the requisite equipment. The laser subsystem is replaceable in the field by a qualified Customer Engineer. The laser chassis is not repairable in the field. Customer engineers are therefore directed to return all chassis and laser subsystems to the factory or service depot when replacement or the optical subsystem is required.

Warning:

Use of controls or adjustment or performance of procedures other than those specified in this manual might result in hazardous radiation exposure.

Two kinds of size notation are employed in this manual. With this machine refer to the inch version.

For good copy quality, Savin recommends that you use genuine toner.

Savin shall not be responsible for any damage or expense that might result from the use of parts other than genuine parts in your office product.

Important

Parts of this manual are subject to change without prior notice. In no event will the company be liable for direct, indirect, special, incidental, or consequential damages as a result of handling or operating the machine.

Power Source:

115V, 60Hz

Please be sure to connect the power cord to a power source as above. For details about power source, see Chapter 10, "Connecting the Power and Switching On" in the Advanced Features manual.

Declaration of Conformity

Product Name: Facsimile

Model Number: 3720/9920

Responsible party: SAVIN CORPORATION

Address: 333 Ludlow Street, Stamford, CT 06904

Telephone number: 203-967-5000

This device complies with part 15 of FCC Rules.

Operation is subject to the following two conditions:

1. This device may not cause harmful interference, and
2. this device must accept any interference received, including interference that may cause undesired operation.

USA**◆ FCC Requirements**

1. This equipment complies with Part 68 of the FCC rules. On the cover of this equipment is a label that contains, among other information, the FCC registration number and ringer equivalence number (REN) for this equipment. If requested, this information must be provided to the telephone company.
2. This equipment uses the following USOC jack: RJ11C
3. The REN is used to determine the quantity of devices which may be connected to the telephone line. Excessive REN's on the telephone line may result in the devices not ringing in response to an incoming call. In most, but not all areas, the sum of the REN's should not exceed five (5.0). Contact the telephone company to determine the maximum REN for the calling area.
4. If this equipment causes harm to the telephone network, the telephone company will notify you in advance that temporary discontinuance of service may be required. If advance notice is not practical, the telephone company will notify the customer as soon as possible. Also, you will be advised your right to file a complaint with the FCC if you believe it is necessary.
5. The telephone company may make changes in its facilities, equipment, operations, or procedures that could affect the operation of the equipment. If this happens, the telephone company will provide advance notice in order to make necessary modifications in order to maintain uninterrupted service.
6. In the event of operation problems (document jam, copy jam, communication error indication), refer to the solving problems section in this manual.
7. If you cannot correct the problem, please contact the RICOH CORP. CUSTOMER SUPPORT DEPT. at 1-800-FASTFIX for repair and warranty information. If it is causing harm to the telephone network, the telephone company may request you to disconnect the equipment from the network until the problem is resolved.
8. This equipment cannot be used telephone company-provided coin service. Connection to Party Line Service is subject to state tariffs.

◆ WHEN PROGRAMMING EMERGENCY NUMBERS AND/OR MAKING TEST CALLS TO EMERGENCY NUMBERS:

1. Remain on the line and briefly explain to the dispatcher the reason for the call before hanging up.
2. Perform such activities in the off-peak hours, such as early morning hours or late evenings.

CANADA

The Industry Canada label identifies certified equipment. This certification means that the equipment meets telecommunications network protective, operational, and safety requirements as prescribed in the appropriate Terminal Equipment Technical Requirements document(s). The department does not guarantee the equipment will operate to the user's satisfaction.

Before installing this equipment, users should ensure that it is permissible to be connected to the facilities of the local telecommunications company. The equipment must also be installed using an acceptable method of connection. The customer should be aware that compliance with the above conditions may not prevent degradation of service in some situations.

Repairs to certified equipment should be coordinated by a representative designated by the supplier. Any repairs or alterations made by the user to this equipment, or equipment malfunctions, may give the telecommunications company cause to request the user disconnect the equipment.

User should ensure for their own protection that the electrical ground connections of the power utility, telephone lines, and internal metallic water pipe system, if present, are connected together. This precaution may be particularly important in rural areas.

Caution: Users should not attempt to make such connections themselves, but should contact the appropriate electric inspection authority, or electrician, as appropriate.

The Ringer Equivalence Number (REN) assigned to each terminal device provides an indication of the maximum number of terminals allowed to be connected to a telephone interface. The termination on an interface may consist of any combination of device subject only to the requirement that the sum of the Ringer Equivalence Numbers of all the devices does not exceed 5.

In accordance with IEC 60417, this machine uses the following symbols for the main power switch:

I means **POWER ON**.

O means **POWER OFF**.

USA**◆ FCC Requirements**

1. This equipment complies with Part 68 of the FCC rules. On the cover of this equipment is a label that contains, among other information, the FCC registration number and ringer equivalence number (REN) for this equipment. If requested, this information must be provided to the telephone company.
2. This equipment uses the following USOC jack: RJ11C
3. The REN is used to determine the quantity of devices which may be connected to the telephone line. Excessive REN's on the telephone line may result in the devices not ringing in response to an incoming call. In most, but not all areas, the sum of the REN's should not exceed five (5.0). Contact the telephone company to determine the maximum REN for the calling area.
4. If this equipment causes harm to the telephone network, the telephone company will notify you in advance that temporary discontinuance of service may be required. If advance notice is not practical, the telephone company will notify the customer as soon as possible. Also, you will be advised your right to file a complaint with the FCC if you believe it is necessary.
5. The telephone company may make changes in its facilities, equipment, operations, or procedures that could affect the operation of the equipment. If this happens, the telephone company will provide advance notice in order to make necessary modifications in order to maintain uninterrupted service.
6. In the event of operation problems (document jam, copy jam, communication error indication), refer to the solving problems section in this manual.
7. If you cannot correct the problem, please contact the SAVIN CORPORATION at 1-203-967-5000 for repair and warranty information. If it is causing harm to the telephone network, the telephone company may request you to disconnect the equipment from the network until the problem is resolved.
8. This equipment cannot be used telephone company-provided coin service. Connection to Party Line Service is subject to state tariffs.

◆ WHEN PROGRAMMING EMERGENCY NUMBERS AND/OR MAKING TEST CALLS TO EMERGENCY NUMBERS:

1. Remain on the line and briefly explain to the dispatcher the reason for the call before hanging up.
2. Perform such activities in the off-peak hours, such as early morning hours or late evenings.

CANADA

The Industry Canada label identifies certified equipment. This certification means that the equipment meets telecommunications network protective, operational, and safety requirements as prescribed in the appropriate Terminal Equipment Technical Requirements document(s). The department does not guarantee the equipment will operate to the user's satisfaction.

Before installing this equipment, users should ensure that it is permissible to be connected to the facilities of the local telecommunications company. The equipment must also be installed using an acceptable method of connection. The customer should be aware that compliance with the above conditions may not prevent degradation of service in some situations.

Repairs to certified equipment should be coordinated by a representative designated by the supplier. Any repairs or alterations made by the user to this equipment, or equipment malfunctions, may give the telecommunications company cause to request the user disconnect the equipment.

User should ensure for their own protection that the electrical ground connections of the power utility, telephone lines, and internal metallic water pipe system, if present, are connected together. This precaution may be particularly important in rural areas.

Caution: Users should not attempt to make such connections themselves, but should contact the appropriate electric inspection authority, or electrician, as appropriate.

The Ringer Equivalence Number (REN) assigned to each terminal device provides an indication of the maximum number of terminals allowed to be connected to a telephone interface. The termination on an interface may consist of any combination of device subject only to the requirement that the sum of the Ringer Equivalence Numbers of all the devices does not exceed 5.

In accordance with IEC 60417, this machine uses the following symbols for the main power switch:

I means **POWER ON**.

O means **POWER OFF**.

How to Read This Manual

How to Read This Manual

Symbols

In this manual, the following symbols are used:

 **WARNING:**

This symbol indicates a potentially hazardous situation that might result in death or serious injury when you misuse the machine without following the instructions under this symbol. Be sure to read the instructions, all of which are described in the Safety Information section in the Advanced Features manual.

 **CAUTION:**

This symbol indicates a potentially hazardous situation that might result in minor or moderate injury or property damage that does not involve personal injury when you misuse the machine without following the instructions under this symbol. Be sure to read the instructions, all of which are described in the Safety Information section in the Advanced Features manual.

* The statements above are notes for your safety.

 **Important**

If this instruction is not followed, paper might be misfed, originals might be damaged, or data might be lost. Be sure to read this.

 **Preparation**

This symbol indicates the prior knowledge or preparations required before operating.

 **Note**

This symbol indicates precautions for operation, or actions to take after misoperation.

 **Limitation**

This symbol indicates numerical limits, functions that cannot be used together, or conditions in which a particular function cannot be used.

 **Reference**

This symbol indicates a reference.

[]

Keys built into the machine's operation panel.

TABLE OF CONTENTS

Manuals for this machine	1
Basic Features (This Manual)	1
Advanced Features	1
1. Introduction	
<hr/>	
Part Names	3
Operation Panel	5
Symbols and Conventions Used in This Manual.....	7
2. Faxing	
<hr/>	
Types of Transmission	9
Suitable Document Types.....	10
Memory Transmission and Immediate Transmission.....	11
Memory Transmission	11
Canceling a Memory Transmission	14
Immediate Transmission	15
Canceling an Immediate Transmission	15
Very Fine Detail Faxing	16
Resolution and Shading	16
Reception Modes	17
Switching Between Fax and Telephone Mode.....	17
3. Setup	
<hr/>	
Initial Settings and Adjustments.....	19
Initial Settings (Function 61).....	19
Storing and Editing Fax Numbers (Functions 31 & 32)	22
Storing, Editing and Erasing Quick Dial Numbers (Function 31)	22
Quick Dial Label	23
Storing, Editing and Erasing Speed Dial Numbers (Function 32)	23
Storing and Editing a Group of Fax Numbers (Function 33).....	25
Erasing Groups	27
Programming the Group Key	28
Entering Characters	29
Entering Symbols	29
Wild Cards.....	29

4. Troubleshooting

Loading Paper in the Main Cassette	31
Adjusting the Volume and Sounds the Machine Makes (Function 92) ...	34
If an Indicator Lights on the Operation Panel	36
Communication Problems	37
Clearing a Document Jam	38
Clearing a Copy, Fax, or Print Jam	39
Main Machine.....	39
Cassette Entrance.....	41
Upper Rear Unit	42
Error Messages	44
Solutions to Common Problems	46
INDEX	50

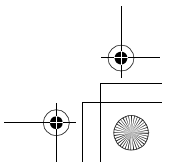
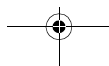
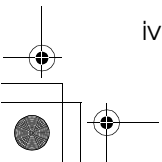
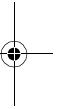
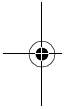
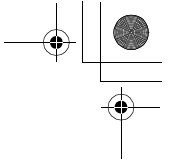
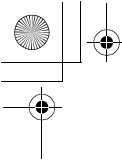

Manuals for this machine

There are the Basic Features manual and the Advanced Features manual for this machine. Please consult the manual that suits your needs.

Basic Features (This Manual)

The Basic Features manual explains the most frequently used fax functions and operations.

Advanced Features

The Advanced Features manual describes more advanced functions, and also explains settings for key operators.

❖ **Chapter 1 Advanced Transmission Features**

Explains about sending at a specific time without having to be by the machine and also taking advantage of off-peak telephone line charges.

❖ **Chapter 2 Communication Information**

Explains about erasing a fax message stored in memory and checking the contents of any files in memory.

❖ **Chapter 3 Transmission Features**

Explains about useful features for transmission. You can find out about dialing numbers easily.

❖ **Chapter 4 Reception Features**

Explains about reception features. You can find out about receiving messages in telephone mode, and printing with the Reverse Order Printing function for easier document distribution.

❖ **Chapter 5 Copying**

Read this chapter when you would like to know about copying operations and functions.

❖ **Chapter 6 Facsimile User Tools**

Explains about programming frequently used functions for Quick Dial Key and User Function Key.

❖ **Chapter 7 Key Operator Settings**

Explains about functions the key operator handles. You can find out about setting up the phone line type, and how to store the Memory Locked ID and the Confidential ID.

❖ **Chapter 8 Troubleshooting**

Explains about clearing a Jam in the optional second cassette, and reading error reports. When these reports are printed out, check the report and take the appropriate action.

❖ **Chapter 9 Maintaining Your Machine**

Explains about loading paper in the optional multipurpose feeder, cleaning the rollers and scanner and so on.

❖ **Chapter 10 Installation**

Explains about the machine environment and installation.

❖ **Chapter 11 Appendix**

You can check the different options and specifications for this machine.

1. Introduction

Part Names

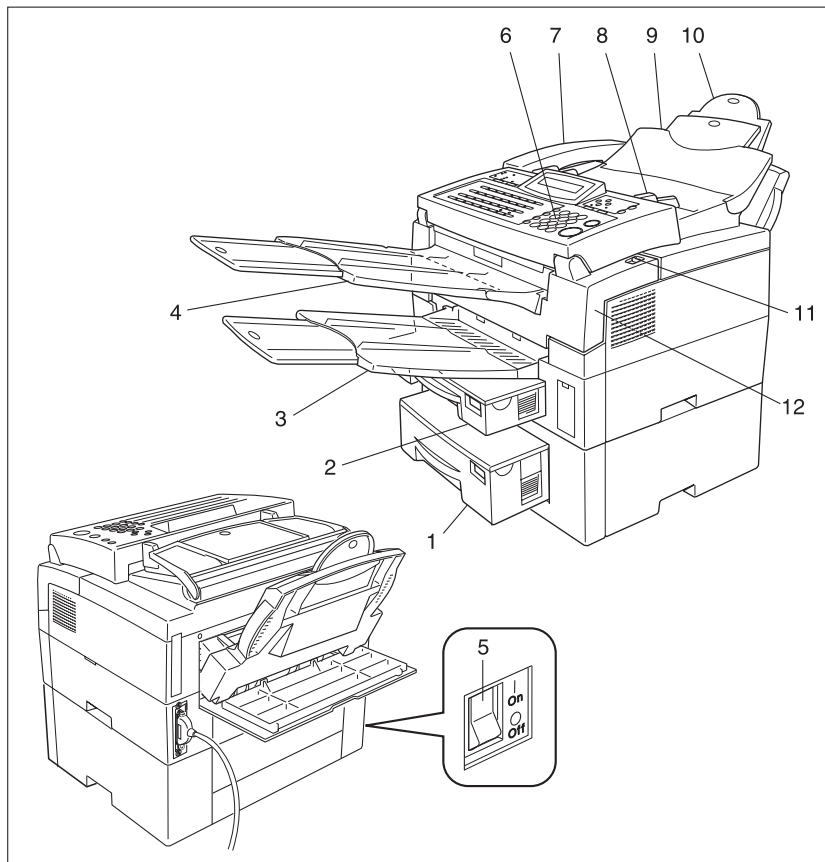

TSTH060N

1. Second Paper Cassette (Option)

The optional Second paper cassette holds more paper.

2. Main Paper Cassette

The main paper cassette holds copy paper.

3. Print Delivery Tray

Copies, incoming faxes, and prints are delivered here.

4. Document Delivery Tray

Scanned documents are stacked on the document delivery tray.

Introduction

5. Main Switch

The main switch turns your machine on and off.

1

6. Operation Panel

Key panel for operating the machine.

7. Handset (Option)

8. Document Guide

Match the document guide to the size of your original documents.

9. Document Table

Document table holds up to 30 sheets which are fed one at a time. Place your original documents here.

10. Multi-purpose Feeder (Option)

Multi-purpose Feeder can be loaded with various kinds of printable media.

11. Front Cover Release Lever

Pull this catch to release the front cover.

12. Front Cover

Operation Panel

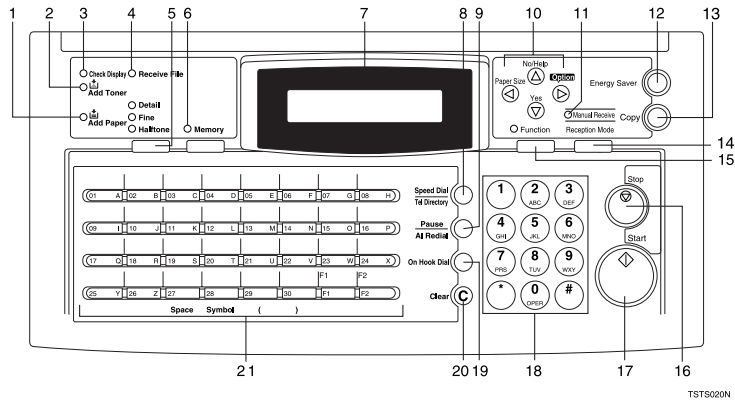

1

1. Add Paper indicator

Lights when a cassette is empty.

2. Add Toner indicator

Blinks when toner is about to run out and lights continuously when toner has run out.

3. Check Display indicator

The **Check Display** indicator lights to tell you to read the display.

4. Receive File indicator

The **Receive File** indicator lights when an incoming message was received into memory. Blinks when confidential reception file or memory lock file is stored in the memory. (see P.36 "If an Indicator Lights on the Operation Panel").

5. [Resolution] key.

The Resolution/Halftone is indicated by these three indicators and can be changed by the **[Resolution]** key. When the Indicator is not lit, Standard is selected.

6. Memory key/ indicator

When the **Memory** indicator is on, then memory transmission is in effect, if it is off, immediate transmission is in effect. Switch between the two with the **[Memory]** key.

7. Control Panel Display

The Liquid Crystal Display guides you through tasks and informs you of the state of the machine. Messages appear here. The display consists of two 20-character lines.

8. [Speed Dial/Tel Directory] key

Press the **[Speed Dial/Tel Directory]** key using Speed Dial or the Telephone Directory Feature.

9. [Pause/Al Redial] key

The **[Pause/Al Redial]** key inserts a pause when you are dialing or storing a fax number. Or, press the key to redial the last number dialed. (The redial feature does not work once you have started dialing a new number.)

10. Arrow keys

▼ **[Yes]** accept

▲ **[No]** reject/ **[Help]** Print help list

◀ scroll left/ **[Paper Size]** The paper size selection screen for each cassette will appear.

▶ scroll right/ **[Option]** Press to access the options.

5

Introduction

1

11. Manual Receive indicator.

Lights when the reception mode is Telephone.

12. [Energy Saver] key

Hold the button a few seconds to start or end the energy saver mode.

13. [Copy] key

Press this to copy the document now in the feeder.

14. [Reception Mode] key

Press this to select the reception mode (Tel or Fax).

15. [Function] key

Press the [Function] key and enter a two digit code to access functions 11 to 53. (For Functions 61 to 95, enter 6, and then the access code.)

16. [Stop] key

Press the [Stop] key to stop a transmission or a document scanning, and a reception or to stop a long copy run. The machine will print out the sheet being printed and then stop.

17. [Start] key

Press the [Start] key to start all tasks.

18. Ten key pad

Use the ten key pad (sometimes called the ten keys) to dial fax numbers, to enter the numbers of copies, etc.

19. [On Hook Dial] key

Press the [On Hook Dial] key to dial a phone call from the keypad without having to lift the phone or handset off the hook (phone or handset option needed).

20. [Clear] key

Press the [Clear] key to erase the last character or digit entered, or use the left and right arrow keys to move the cursor and then press Clear to erase whatever is at the cursor.

21. [Quick Dial] keys/ [User Function] keys.

There are 30 Quick Dial keys. Use them to store individual fax numbers (see P.22 "Storing and Editing Fax Numbers (Functions 31 & 32)") or groups (see P.25 "Storing and Editing a Group of Fax Numbers (Function 33)"). You can also use these keys to enter characters (see P.29 "Entering Characters"). In addition you can register Quick Dial 29 as the Dial Option key (see Chapter 3, "Assigning the Dial Option key" in the Advanced Features manual.) You can also use Quick Dial 30 as a Group key (see P.28 "Programming the Group Key").

You can store a combination of settings that you use frequently in the two User Function keys (F1, F2). When you press a User Function key, it lights to show you that it is selected.

Symbols and Conventions Used in This Manual

1

◆ Documents:

A document is anything you put on the feed table of your machine whether you are faxing it or copying it.

◆ Prints:

A print is anything that comes out of the machine: a fax message you received or a copy you made.

◆ Procedures:

Procedures are described step by step. Perform them in order. When you see a display, it always shows what comes after performing the step it accompanies. Other illustrations accompanying steps help you find the right key, or show you how to perform the step.

■ This is a step in a procedure.

THIS CORRESPONDS TO
THE LCD DISPLAY.

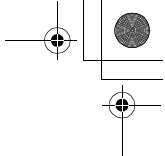
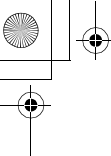

Introduction

1

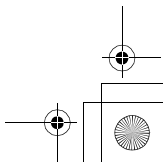
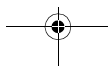
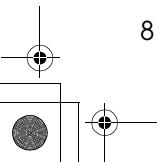
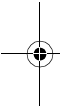

2. Faxing

Types of Transmission

There are two types of transmission.

◆ Memory Transmission

When a fax message is stored in memory, then transmission starts automatically. It is convenient when you would like to take documents back in a hurry. You can send the same message to more than one destination in a single operation. This technique is referred to as Broadcasting.

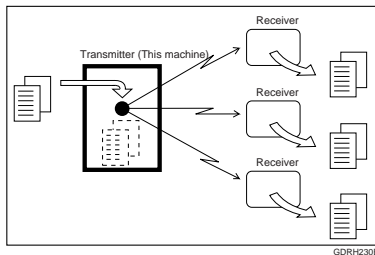

◆ Immediate Transmission

The machine dials immediately, and transmits the fax while scanning. It is convenient when you would like to check whether you have successfully connected with the other party's fax machine. A fax message is not stored in memory.

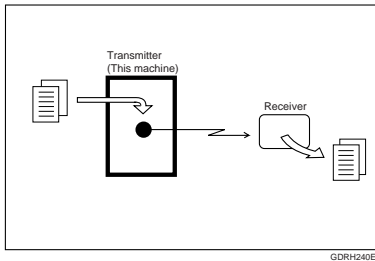

⚠ Important

- If there is a power failure, the power switch is turned off, or the plug is pulled out for more than 6 hours (1 hour when the optional memory card is installed), all files stored in memory are deleted. As soon as power is restored, the Power Failure Report is printed to help you identify deleted files. See Chapter 8, "Power Failure Report" in the Advanced Features manual.

Suitable Document Types

Do not place damaged pages in the automatic document feeder.

- If pages are curled or dog eared, flatten them.
- If pages are stuck together, shuffle the stack.
- If pages are folded, torn, or patched together, make copies.
- If pages have binding files, trim the edges or make copies.

2

Important

Do not place originals that contain the following materials in the document feeder ;

- Crayon
- Paint
- Charcoal, soft pencil
- Glue
- Thermal paper
- Clips
- OHP Sheets, vinyl-coated paper
- Waxed paper
- Carbon paper
- Silicone oil

Note

Copies made with a copier that uses silicone oil may cause a misfeed. To avoid this, do not scan such copies until five or ten minutes after copying.

- Clearly Written
Small, faint characters may not be transmitted clearly.
- Uniform Page Size
Do not use different size documents in the same transmission.

Memory Transmission and Immediate Transmission

There are two ways to send a fax message.

- Memory Transmission
- Immediate Transmission

Memory Transmission

A Memory Transmission is convenient because:

- Fax messages can be scanned much more quickly (you can take your document away from the fax machine without waiting too long).
- While your fax message is being sent, another user can operate the machine (people will not have to wait by the fax machine too long).
- You can send the same message to more than one place with the same operation.
- There are two kinds of Memory Transmission: Parallel and Normal. Parallel Memory Transmission is the default.

Note

- If your document gets stuck while it is being processed, press the **[Stop]** key, and turn to P.38 "Clearing a Document Jam" for instructions on how to safely remove the original.

1 Make sure that the machine is in standby mode for faxing.

The display should look like this:

```
READY 100% 10:00AM
SET DOC. OR DIAL NO.
```

Note

- If the display is blank, press the Energy Saver key to exit Energy Saving mode.

2 Fan your document stack (at most 30 pages: 20 lb) to make sure all pages are loose, then square it.

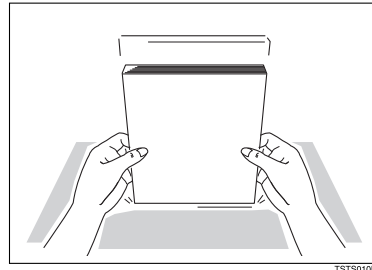

Note

- All pages in your document must be one-sided and be of the same size.

2

Faxing

3 Insert the document face down into the feeder until the machine beeps. Then adjust the guides to match the width of the document.

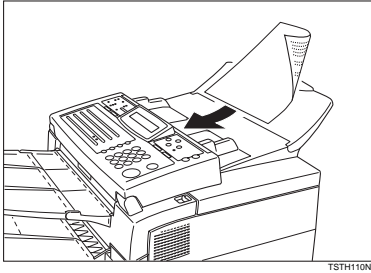

2

Note

- You can dial before you set the document. Place the document after you dial the number and go to step 7.
- Please set your document straight in the feeder. If you set more than 15 sheets, make sure the ends of your document are not skewed.

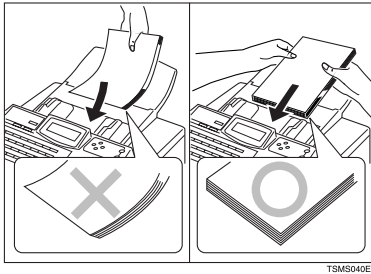

4 The display will look like this:

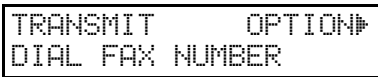

5 If the Memory indicator is not lit, press the **[Memory]** key.

6 Dial the number in one of the following ways.



Ten Key Pad	Quick Dial
Speed Dial	Group
<p>Example: Speed Dial 10</p>	<p>Example:</p> <p>Method *1 Quick Dial key 08.</p> <p>Method *2 Quick Dial key 30 and 1 on the ten key pad.</p>

*1 In this example Group Dial is programmed in Quick Dial 08.
 *2 In this example Quick Dial key 30 is programmed as the Group key, and Group dial number 1 is programmed.

Note

- If you install the handset or an external telephone, you can send the message manually. Pick up the handset and dial.
- If you want to erase a digit of the phone number, press the **[Clear]** key. If you want to erase the entire number, press the **[No]** key.
- The maximum destinations you can dial using the ten key pad is 68. However, this limitation is also subject to memory capacity.

Reference

Programming Quick Dial: see P.22 "Storing and Editing Fax Numbers (Functions 31 & 32)".

Programming Speed Dial: see P.22 "Storing and Editing Fax Numbers (Functions 31 & 32)".

Programming Group Dial: see P.25 "Storing and Editing a Group of Fax Numbers (Function 33)".

Programming Group key: see P.28 "Programming the Group Key".

7 Press the **[Yes]** key to enter another number.

```
TRANSMIT DIAL/START
DIAL NEXT FAX NUMBER
```

Note

- Repeat steps **6** and **7** until all destinations are entered.
- If you have only one destination, press the **[Start]** key.
- The machine stores your message and dials the first number (or, if you selected Send Later, it will return to standby mode and the fax message will be sent at the time that you selected).

Reference

Send Later: see Chapter 1, "Sending at a Specific Time (Send Later)" in the Advanced Features manual.

8 Press the **[Start]** key.

The machine will dial the destination's number.

```
5551234
SET DOC. OR DIAL NO.
```

Note

- If the other party's line is busy, your machine will redial. (See Chapter 3, "Redial" in the Advanced Features manual.)

```
READY 98% 10:04AM
SET DOC. OR DIAL NO.
```

- If the other party's fax machine answers, both machines will connect and your machine will send the message. Other party's OWN NAME or FAX NUMBER will appear on the upper line.
- If your line goes through a local switchboard (a PBX) remember to dial the exit code. Press the **[Pause]** key immediately after the code. If the number includes a country code, press the **[Pause]** key after the country code, then dial the rest of the number.

Faxing

Canceling a Memory Transmission

Before start is pressed

2

- 1 Press the **[Stop]** key, or remove the document You have set.

While the document is being scanned in

- 1 Press the **[Stop]** key.
The fax message which has already been scanned in is cancelled.

During Transmission

- 1 Press the **[Stop]** key during communication.

```
5551234
STOP & CLR FILE? Y/N
```

- 2 Then press the **[Yes]** key to cancel the transmission.

While the message is awaiting transmission (Functions 21)

Every time you store a fax message in your machine's memory, a new file is created. Each file is given a number. This number appears on the File Reserve Report, Journal and Transmission Result Report. To see which files are currently in memory, you may print a file list.

- 1 Either :

To erase a fax message stored in memory

- 1 To erase a fax message stored in memory; press the **[Function]** **[2]** **[1]** and the **[Yes]** key.

```
FILE NO. ■■■■ KPAD/↔
PRINT LIST↔/SEARCH↔
```

- 2 Press **▶** to scroll through the messages.

You will see the display. A number or a label will appear on the lower line.

```
FILE NO.027 Y/↔
5551234
```

Note

- Press **◀** to obtain a list of all the files and their number. If you already know the number of the file to erase, enter it directly from the ten key pad.

- 3 Press the **[Yes]** key.

```
FILE NO.027 Y/N
CLEAR?
```

- 4 Press the **[Yes]** key again to erase the file.

- 5 Press the **[Function]** key.

Note

- To erase another file, go to step 2.

Immediate Transmission

Immediate Transmission is convenient when:

- You wish to quickly check whether you have successfully connected with the other party's fax machine.
- Your machine's memory is getting full.

The machine dials immediately after you press the **[Start]** key (or at the specified time, if you used a time-delay feature like Send Later). The message is scanned and transmitted page by page without being stored in memory.

- 1** Make sure that the machine is in standby mode.

The display should look like this:

```
READY 100% 10:00AM
SET DOC. OR DIAL NO.
```

Note

- The memory indicator should go out. If the memory indicator is lit, press the **[Memory]** key.

- 2** Place the entire document face down into the feeder.

```
TRANSMIT OPTION▶
DIAL FAX NUMBER
```

Note

- No more than 30 pages.
- You can dial before you set the document. Place the document after you dial the number and go to step **3**.

- 3** Dial.

```
TRANSMIT V/START
5551234
```

- 4** Press the **[Start]** key.

```
5551234
DIALING
```

The machine dials and connects to the other party. The number that you dialed and the other party's OWN NAME or FAX NUMBER is displayed.

Canceling an Immediate Transmission

Before start is pressed

- 1** Press the **[Stop]** key, or remove the document you have set.

While dialing or during transmission

- 1** Press the **[Stop]** key.

However, the fax message which has already scanned in has transmitted.

Remove the document after it is canceled.

2

So that text, diagrams and images stand out clearly in your document, the machine automatically detects the image density (contrast) and makes a compensation.

However, if you need to send a document which requires optimum clarity, select the resolution setting appropriate to your needs.

You can select different settings for each page of your message. Simply change the settings for page 2 while page 1 is being scanned.

Resolution and Shading

The resolution button gives you control over document quality. The indicators above the button show the current setting. Choose a setting that matches your document.

◆ **Standard:**

Standard quality. Use for most printed or typewritten documents. This is selected when the other resolution indicators are not lit.

◆ **Detail:**

High quality. Use for documents with small print or fine details.

◆ **Fine:**

Very high quality. Use this for high quality reproduction.

◆ **Halftone:**

Use this for optimum quality if your document contains photographs/diagrams with complex shading patterns or gray tones. If you choose this setting, resolution will automatically be Detail.

 **Note**

- Faxing at a higher resolution requires more time. Frequent use of high resolution could cause an increase in your phone bill, especially for long distance transmissions.

Reception Modes

The machine can treat incoming fax messages and telephone calls in three ways.

❖ Auto mode

Use this mode if your line is shared by a fax machine and telephone. When a call comes in, the machine will ring a number of times to give you the chance to pick up the handset. If you do not pick up and the call is a fax message, the machine will go into fax mode and start receiving. You can choose the number of times the machine rings before taking the call by altering the Auto Ring time (See Chapter 7, "Setting the Auto Ring Time" in the Advanced Features manual).

❖ Fax mode

Use this mode if you have a dedicated fax line. The machine assumes all calls are fax messages. It will ring once to alert you of an incoming call, and then starts receiving.

❖ Telephone mode

Use this mode if your line is shared by a fax machine and a telephone, and if you wish to answer all calls yourself and decide whether they are fax messages or telephone calls. You must manually press the Start key to receive a fax.

The machine will ring continuously until you answer the call, so you have to be near the machine at all times.

The Manual Receive indicator is lit when the machine is in this mode.

Switching Between Fax and Telephone Mode

The Manual Receive indicator is lit when the machine is in Telephone mode. To switch to a different mode, follow the steps below.

- 1 Press the **[Reception Mode]** key.

```
RECEIVE MODE  Y/⬅➡
▶FAX TEL AUTO
```

- 2 Press the **◀** and **▶** key to select the mode you require.

```
RECEIVE MODE  Y/⬅➡
FAX ▶TEL AUTO
```

- 3 Press the **[Yes]** key.

```
READY 100% 10:00AM
SET DOC. OR DIAL NO.
```

2

Faxing

2

3. Setup

Initial Settings and Adjustments

Before you connect your machine to the telephone system, you must enter a few settings and make a few adjustments.

❖ **Own Number :**

The phone number used by your fax line.

❖ **OWN NAME:**

This should be your name or company name, in 20 characters or less. During a communication, if the other party's fax machine supports OWN NAME, then this replaces the FAX NUMBER following. The other party's name will appear on your display, and yours on theirs.

❖ **FAX HEADER:**

This must be the telephone number of the line your machine is connected to.

It will be printed on the header of every page you send. Required in the United States.

❖ **FAX NUMBER:**

This is your fax machine's phone number, which must include country and area codes. During any communication, your FAX NUMBER appears on their display. (Conversely their FAX NUMBER appears on your display.)

 **Note**

- This function is not available in some areas.

 **Important**

- The FAX NUMBER code is required by international law. You cannot legally connect a fax machine to the telephone system if the FAX NUMBER code is not programmed. Further, the FAX HEADER code and the date and time of transmission must be included in the header of all pages faxed to, from, or within the United States.

 **Note**

- When the PC Interface kit is installed, "OWN NAME" is displayed as "RTI", "FAX HEADER" is displayed as "TTI", and "FAX NUMBER" is displayed as "CSI".

Initial Settings (Function 61)

During the course of this procedure you will have to enter letters and other characters.

Use the ten key pad for entering numbers. Use Quick Dial keys 1 to 26 for entering letters. Use the **[Yes]** key to accept a character. Use Quick Dial key 27 to enter spaces and Quick Dial key 28 to enter symbols. See P.29 "Entering Characters" for details.

If these settings have been made before, the messages on the display will not always match those shown here. The setting already entered will appear along with the word CHANGE?. In this case, press the **[Yes]** key to change the setting.

Setup

- 1 Press **[Function]** **[6]** and enter the access code **[2]** **[2]** **[2]** **[2]**, and then press **[6]** **[1]** and the **[Yes]** key.

```

                                Y/NEXT▶
SET OWN NUMBER
    
```

- 2 Press the **[Yes]** key.

3

```

OWN NO.          KPAD
████████████████████████████████████████
    
```

- 3 Enter your phone number.

```

OWN NO.          KPAD/Y/N
0111212-5551234██████████
    
```

Note

- The format of the number is normally as follows: International Dial Prefix, Your Country Code, Your Area Code, then you must add a Pause, followed by your telephone number. Check the International Dialing Prefix and the Country Code with your local telecommunications operator. The example shown is for the United States; the codes to add are 011 and 1.

- 4 Press the **[Yes]** key.

PROGRAMMED will flash on the display. The following display appears.

```

                                Y/NEXT▶
SET POLLING ID
    
```

- 5 Press **▶** until the following display is shown.

```

                                Y/NEXT▶
SET OWN NAME
    
```

- 6 Press the **[Yes]** key.

```

OWN NAME          ABC
████████████████████████████████████████
    
```

- 7 Enter your office, company, or personal name, or any other appropriate identification. (Using the Quick Dial keys.)

```

OWN NAME          ABC Y/N
XYZ COMPANY
    
```

Reference

See P.29 "Entering Characters".

- 8 Press the **[Yes]** key.

PROGRAMMED will flash on the display. The following display appears.

```

                                Y/NEXT▶
SET FAX HEADER
    
```

- 9 Press the **[Yes]** key.

The OWN NAME programmed in step 8 appears. You should keep it.

```

HEADER CHANGE? Y/N
XYZ COMPANY
    
```

Note

- If you wish to change it, press the **[Yes]** key and edit the FAX HEADER.

Setup

Storing and Editing Fax Numbers (Functions 31 & 32)

You can store numbers that you often use in the machine's memory. A stored number will remain in memory even if the power is cut.

You can store numbers in two ways.

3

◆ Quick Dials

The number is assigned to its own key. To dial that number, just press the key. You can store up to 30 numbers in this way.

◆ Speed Dials

The number is given a two-digit code. To dial the number, press the **[Speed Dial]** key and enter the code. There are 50 Speed Dial codes available, numbered 00 to 49.

Storing, Editing and Erasing Quick Dial Numbers (Function 31)

This procedure describes how to store and edit fax numbers in Quick Dial keys.

- 1 Press **[Function]** **[3]** **[1]** and then the **[Yes]** key.



QUICK/SEARCH
PRINT LIST

✎ Note

- To print a list of all Quick Dials and their contents, press the **[Left Arrow]** key, and the **[Yes]** key, and then the **[Start]** key.

- 2 Select a Quick Dial in any one of the following ways:

- Press a Quick Dial key (e.g. press Quick Dial 01).



001 PROGRAM? Y/SEARCH

- Press the **[Right Arrow]** key until the Quick Dial you want appears on the display.

- 3 Press the **[Yes]** key.



001 KPAD/Y/N

- 4 Do one of the following:

- Enter the fax number you wish to store in this Quick Dial using the ten key pad. Then press the **[Yes]** key.



001 KPAD/Y/N
212551234

- To clear the number, press **[No]**, and go to step 4.

- 5 Do one of the following:

- If you wish to enter or edit a label for this Quick Dial, press the **[Yes]** key.

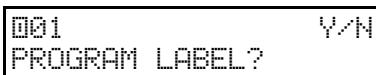

001 PROGRAM LABEL? Y/N

- If you do not wish to give this number a label, press the **[No]** key and go to step 4.

- 6** Enter or edit the label using the Quick Dial keys and the ten key pad. See P.29 "Entering Characters"

```
001          ABC Y/N
NEW YORK OFFICE
```

- 7** Press the [Yes] key.

```
001          Y/
LABEL SET ON/OFF
```

- 8** Press ◀ or ▶ to select whether the label for this Quick Dial will be printed on top of messages that you send to this destination.

- 9** Press the [Yes] key.

```
QUICK/
PRINTLIST/SEARCH
```

Note

- To print a Quick Dial list, press the ◀ key to select LIST, then press the [Start] key.
- To print a Quick Dial label, choose LABEL, and then press the [Start] key.

- 10** You now have two choices:

- To store, edit or delete another Quick Dial, go to step 2.
- To finish, press [Function] key.

Quick Dial Label

Use this function to print a sheet showing the contents of each Quick Dial and User Function key. The size of the sheet matches the dimensions of the keys.

The following items are printed depending on what is stored in each key:

- Fax number label
- Group Dial label
- Program label
- User Function key

3

Storing, Editing and Erasing Speed Dial Numbers (Function 32)

This procedure describes how to store and edit fax numbers in Speed Dials.

- 1** Press [Function] [3] [2], and then the [Yes] key.

```
KPAD/
PRINT LIST/SEARCH
```

Note

- To print a list of all Speed Dials and their contents, press the ◀ key, and then the [Start] key.

- 2** Select a Speed Dial in any one of the following ways:

- Enter the Speed Dial code on the ten key pad. (e.g. 01)

```
001 PROGRAM? Y/
```

- Press the ▶ key until the Speed Dials you want appear on the display.

Setup

3 Press the **[Yes]** key.

4 Do one of the following:

- Enter the fax number you wish to store in this Speed Dial using the ten key pad. Then press **[Yes]** key.

3

- To clear the number, press **[No]**, and go to step **4**.

5 Do one of the following:

- If you wish to enter or edit a label for this Speed Dial, press the **[Yes]** key.

- If you do not wish to give this number a label, press the **[No]** key and go to step **5**.

6 Enter or edit the label using the Quick Dial keys.

7 Press the **[Yes]** key.

8 Press **[Left]** or **[Right]** to select whether the label for this Speed Dial will be printed on top of messages that you send to this destination.

9 Press the **[Yes]** key.

Note

- To print a Speed Dial list, press the **[Left]** key, and then the **[Start]** key.

10 You now have two choices:

- To store, edit or delete another Speed Dial, go to step **2**.
- To finish, press the **[Function]** key.

Storing and Editing a Group of Fax Numbers (Function 33)

◆ Groups

If you often broadcast messages to the same set of destinations, you can combine these numbers into a group. Then just select the group and each number will be dialed in sequence automatically.

You can register the following items in a Group:

- Destination fax numbers
- Group name (up to 20 characters)

You can enter destination numbers by Quick Dial keys, Speed Dials, or Ten keys.

📌 Note

- ❑ You can register up to 5 Groups.
- ❑ The combined maximum number of destinations you can register in all Groups is 129. This 129 can be composed of up to 30 Quick Dial numbers, 50 Speed Dial numbers and 49 numbers entered directly with the ten keys.
- ❑ The number of destinations that can be registered with the ten keys depends on how the machine is used. In theory you can register up to a combined maximum of 49 destinations with the ten keys for all groups. However, if you register 49 items with the ten keys, Memory Transmission becomes unavailable, only register up to 48 items with the ten keys.
- ❑ The maximum number of destinations you can register in a Group is 100.

- ❑ If you register the same destination more than once with a Speed Dial or Quick Dial in Groups, it is only counted as one item. However, if you register two or more identical destinations with the ten keys they will be counted as two or more items.
- ❑ If all destinations are different, you may not be able to store 100 destinations in a Group.
- ❑ It is recommended that you print the Group Dial list and keep it when you register or change destinations. See Chapter 6, "Reports You Can Print Out Yourself" in the Advanced Features manual.
- ❑ How to count numbers

3

	Registered items	Total Numbers
Group 1	Quick Dial: [01], [03], [05] Speed Dial: [01], [02], [10] Ten Key: 0312345678	10 numbers
Group 2	Quick Dial: [01], [05] Speed Dial: [01], [02], [08] Ten Key: 0312345678, 0451119999	

Setup

3

	Registered items	Total Numbers
Group1	Quick Dial: [01], [02], [03] Speed Dial: [01], [02], [03] Ten Key: 0312345678	14 numbers
Group2	Quick Dial: [04], [05] Speed Dial: [04], [05], [06] Ten Key: 0312345678, 0451119999	

This section describes how to program or edit a Group. You can also get a printout of numbers that are already stored. In this example we will program Group 1 into Quick Dial key 01.

1 Press **[Function] [3] [3]**, and then the **[Yes]** key.

```
GROUP █ 1-5/➡
PRINT LIST4/SEARCH
```

2 Enter the number of the group you want to program or edit.

Note

- e.g. Group 1: Press **[1]**.
- To print a list, press the **◀** key and then the **[Start]** key.

3 Press the **[Yes]** key.

```
GROUP 1 Y/N
PROGRAM QUICK?
```

4 To program or edit a Quick Dial key for this group, press the **[Yes]** key.

Note

- If you do not program or edit, press the **[No]** key and go to step **6**.

5 Press the Quick Dial key you wish to use for this group, **[01]** for example, and then press the **[Yes]** key.

Note

- If you want to free up the old Quick Dial key, press the **[No]** key, and then the **[Yes]** key.

```
GROUP 1 Y/N
PROGRAM LABEL?
```

- If a message like USED AS.. flashes up, the key is already in use. Press a different key.

6 If you wish to give this group a name, press the **[Yes]** key.

```
GROUP 1 ABC
████████████████████████████████████████
```

Note

- If not, press the **[No]** key and go to step **6**.

7 Enter or edit the name, and then press the **[Yes]** key.

How to enter characters, see P.29 "Entering Characters"

```
GROUP 1 KPAD/N
████████████████████████████████████████
```

8 Enter a fax number. **Note**

- Enter a number in one of these ways.
 - Press a Quick Dial key.
 - Press the Speed Dial key followed by two digits.
 - Enter a number on the ten key pad.

9 Press the **[Yes]** key. **Note**

- If **ALREADY PROGRAMMED** briefly flashes up on the display, either press the **[No]** key to keep the number and choose another number, or press the **[Yes]** key to clear.

10 Press the **[No]** key to finish entering numbers in this group. **Note**

- To enter another number, go back to step **8**.

11 Press the **[Function]** key. **Note**

- To work on another group, go to step **2**.

Erasing Groups

These steps describe how to erase single numbers from a group.

- 1** Press **[Function]** **[3]** **[3]**, and then the **[Yes]** key.

```
GROUP █ 1-5/☎
PRINT LIST ☎/SEARCH☎
```

3

- 2** Enter the group number using the ten key pad, then press the **[Yes]** key.

```
GROUP 1 Y/N
PROGRAM QUICK?
```

- 3** Press the **[No]** key.

```
GROUP QUICK/N
PROGRAM LABEL?
```

- 4** Press the **[No]** key.

```
GROUP 1 Y/N
CLEAR?
```

- 5** Press the **[Yes]** key.

```
GROUP 1 Y/N
CLEARED
```

- 6** Press the **[Function]** key.

 **Note**

- To delete another number, go to step **2**.

Programming the Group Key

You can program 5 groups. However, if there is no room in Quick Dial keys, this group key is helpful. You can use Quick Dial 30 or one of User Function keys (F1 or F2) as the group key. How to transmit using the group key, see P.11 "Memory Transmission".

3

Reference

For how to program User Function keys, see Chapter 6, "User Function Keys (Function35)" in the Advanced Features manual.

- 1 Press **[Function] [3] [1]**, and then the **[Yes]** key.



QUICK/SEARCH
PRINT LIST/SEARCH

- 2 Press the Quick Dial **[30]**.

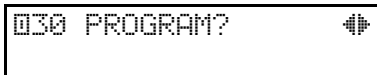

030 PROGRAM?

- 3 Press the **[Yes]** key.



030 PROGRAM? Y/N
PROGRAM GROUP KEY?

- 4 Press the **[Yes]** key.



QUICK/SEARCH
PRINT LIST/SEARCH

- 5 Press the **[Function]** key.

Entering Characters

Use the ten key pad for entering numbers. Use Quick Dial keys 1 to 26 for entering letters, and Quick Dial key 27 for spaces and Quick Dial key 28 for other characters.

If at any time you make a mistake when entering a character or digit, press the **[Clear]** key to erase it. To correct a character or number already entered, use the **◀** and **▶** keys to reach the mistake, enter the new character, and press the **[Clear]** key to erase the mistaken character. If you press the **[No]** key, whole characters are erased.

Entering Symbols

1 Press the Quick Dial key **[28]**.

2 Press **◀** or **▶** to scroll the symbols.

 **Note**

- You can enter the following symbols. & \$! " # % ' () * + , . / : ; [¥] ^ _ - (space)

3 Press the **[Yes]** key.

Wild Cards

This feature greatly enhances the effectiveness of the following features:

- Authorized Reception
- Forwarding
- Specified Cassette Selection
- Memory Lock

In each of these features, you have to store the OWN NAME or FAX NUMBER of various terminals that you normally receive fax messages from. Then, when your machine detects an incoming call, it checks the OWN NAME or FAX NUMBER of the other terminal, and acts accordingly.

When you program OWN NAME's for these features, you can program wild cards to greatly expand the number of terminals that you can specify.

For example, if you wish to accept messages from all 150 branches of XYZ Company (using Authorized Reception), and forward them on to head office (using Forwarding), you do not have to store the OWN NAME of each branch of XYZ Company. Program "XYZ" as a wild card for each of these functions. If the OWN NAMES of all XYZ branches contain an "XYZ" somewhere in the OWN NAME, messages coming in from them will be accepted, and sent on to head office.

 **Note**

- This feature cannot recognize spaces. If you store MAN as a wild card, and a terminal with an OWN NAME that includes MANCHESTER, HUMAN, or HUMANE calls you, your machine will recognize MAN as a wild card and accept and/or forward the message.

 **Reference**

Authorized Reception: see Chapter 7, "Rejecting or Accepting Messages from specified senders (Authorized Reception)" in the Advanced Features manual.

Forwarding: see Chapter 7, "Forwarding" in the Advanced Features manual.

OWN NAME and FAX NUMBER: see P.19 "Initial Settings and Adjustments".

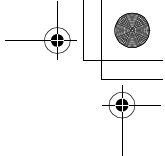
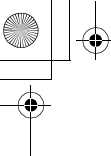

Setup

3

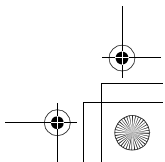
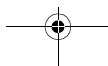
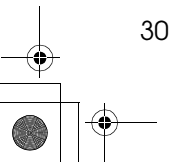
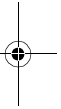
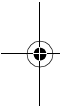

4. Troubleshooting

Loading Paper in the Main Cassette

- 1** Pull out the paper cassette and place it on a flat surface.

 **Note**

- Remove any paper that may have dropped inside the machine in the area vacated by the paper cassette.

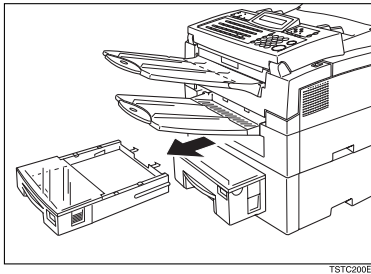

TSTC200E

- 2** Lift up the cassette cover and remove it.

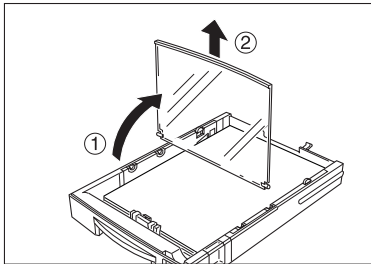

TSTC100N

- 3** Remove any remaining paper.

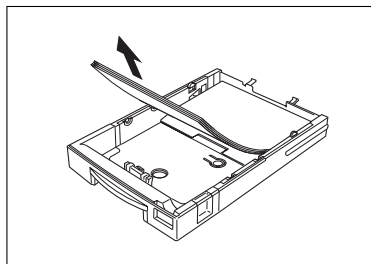

TSTC270N

Troubleshooting

- 4** If the metal base plate is raised, push it firmly down until it locks into place.

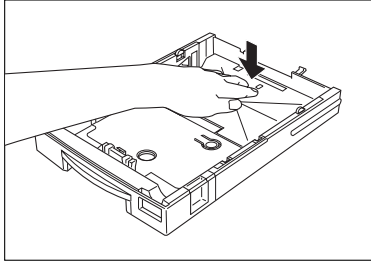

TSTC060N

4

- 5** Prepare a stack of blank paper. For smoother operation, square the edges.

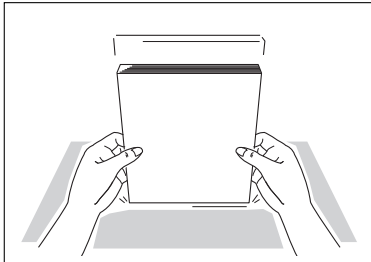

TSTS010N

- 6** Load the paper into the cassette.

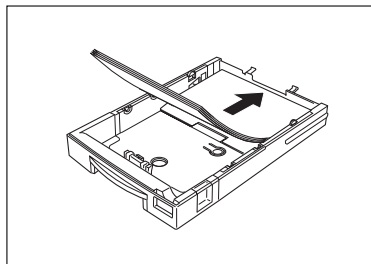

TSTC210N

7 Replace the cassette cover.

Note

- The frosted side of the cover must be face up when closed.

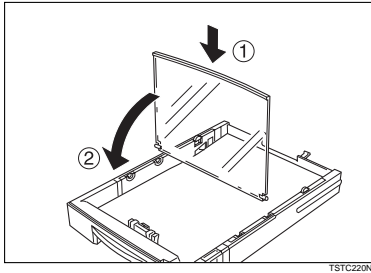

8 Replace the cassette. Push it in firmly until it locks into place.

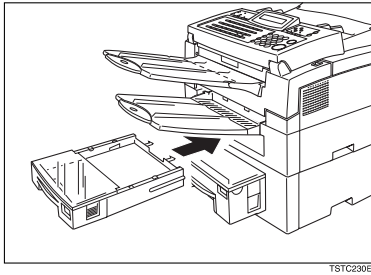

Adjusting the Volume and Sounds the Machine Makes (Function 92)

You can change the beeper (monitor) volume of the desired feature.

TRANS MONITOR	The sound of signal transmissions.
RECV MONITOR	The sound of signal receptions.
ONHOOK MONITOR	The sound of signal on hook dialing.
DIAL MONITOR	The sound when a number is dialed.
BUZZER	The sound (does not buzz) of signal something going amiss.
KEY	The sound when a key is pressed.

4

- 1 Press **[Function]** **[6]** and enter the access number **[2]** **[2]** **[2]** **[2]**. Then press **[9]** **[2]**.

```
ADJUSTMENT  Y/NEXT▶
92 ADJUST VOLUME
```

- 2 Press the **[Yes]** key.
- 3 Adjust the transmission monitor volume with the **◀** and **▶** keys, and then press the **[Yes]** key when finished.

```
TRANS MONITOR  Y/◀▶
MIN ▶▶▶      MAX
```

- 4 Adjust the reception monitor volume with the **◀** and **▶** keys, and then press the **[Yes]** key when finished.

```
RECV MONITOR  Y/◀▶
MIN ▶▶▶      MAX
```

- 5 Adjust the on hook monitor volume with **◀** and **▶** keys and press the **[Yes]** key when finished.

```
ONHOOK MONITOR Y/◀▶
MIN ▶▶▶      MAX
```

- 6** Adjust the dial monitor volume with the ◀ and ▶ keys, and then press the **[Yes]** key when finished.

```
DIAL MONITOR  Y/◀▶  
MIN ▶▶▶      MAX
```

- 7** Adjust the BUZZER monitor volume with the ◀ and ▶ keys, and then press the **[Yes]** key when finished.

```
BUZZER        Y/N/◀▶  
MIN ▶▶▶      MAX
```

- 8** Adjust the KEY volume with the ◀ and ▶ keys, and then press the **[Yes]** key when finished.

```
KEY           Y/◀▶  
MIN ▶▶▶      MAX
```

- 9** Press the **[Function]** key to return to standby mode.

If an Indicator Lights on the Operation Panel

❖ **PRESS STOP KEY** appears in the display:

Press the **[Stop]** key.

❖ **The Receive File indicator is lit:**

You have received a fax message which is now stored in the memory. See Chapter 4, "Printing Message That Have Been Received into Memory (Substitute Reception)" in the Advanced Features manual.

❖ **The Check Display indicator is lit:**

Read the message on the display and check the descriptions listed on P.44 "Error Messages".

4

Communication Problems

If **ERROR PRESS STOP** appears in the display: Press the **[Stop]** key.

ERROR PRESS STOP KEY

Causes:

- A poor line caused the communication to fail.
- The line is noisy. Try to transmit the fax message again.
- The other machine is out of order. Ask the other party to check their machine.

Troubleshooting

Clearing a Document Jam

When an original is jammed, CLEAR ORIGINAL is displayed, follow this procedure to solve the problem.

Note

- If copies, fax message or prints are jammed, follow the next procedure.

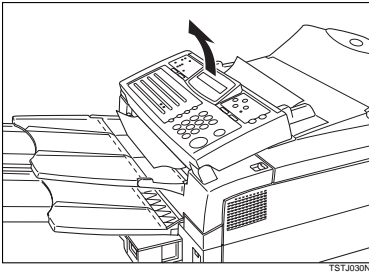
1 Open the operation panel to an angle of about 45°.

4

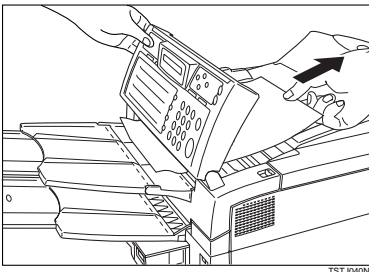
2 Remove the original.**Important**

- Do not pull out the document without opening the operation panel, or you will damage the scanning mechanism.

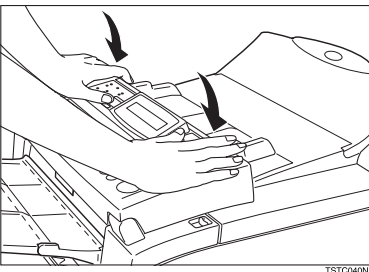
3 Close the operation panel.

Clearing a Copy, Fax, or Print Jam

When CLEAR COPY is displayed, follow this procedure to solve the problem. For clearing original jams, see the previous procedure.

Main Machine

- 1** Pull the front cover release lever towards you and open the front cover.

 **Note**

- If you do not pull the lever, only the upper unit will open.

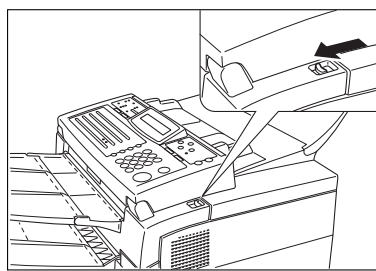

4

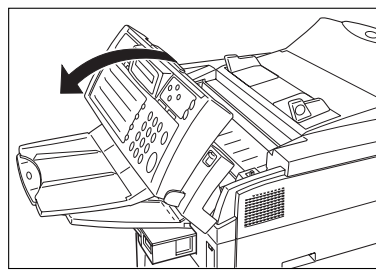

- 2** Remove the toner cassette.

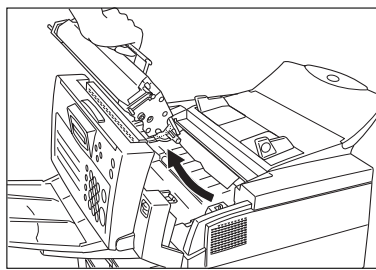

Troubleshooting

3 Remove any jammed paper underneath.

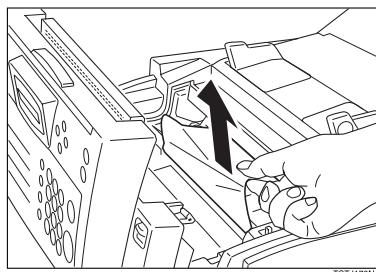

4 Replace the toner cassette.

4

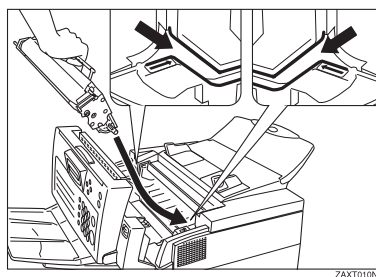

5 Close the front cover.

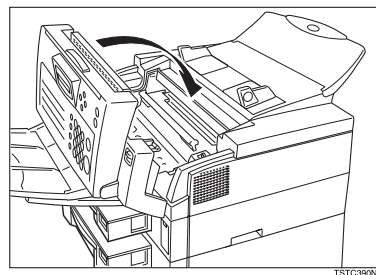

Cassette Entrance

- 1** Remove the main cassette and place it on a flat surface.

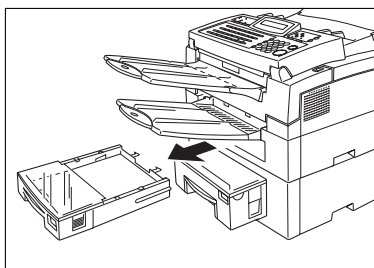

TSTC200E

- 2** Remove any paper from inside the machine.

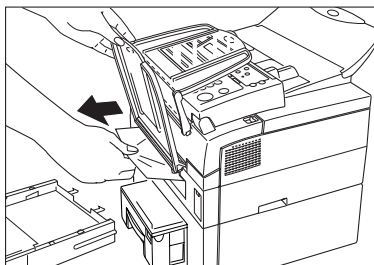

TSTJ080N

- 3** Push down the paper so that the base plate locks into place.

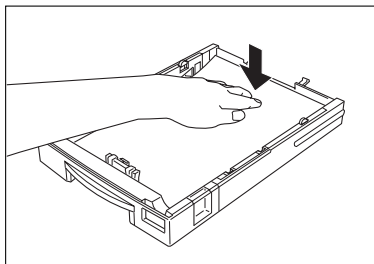

TSTJ090N

4

Troubleshooting

4 Replace the main cassette.

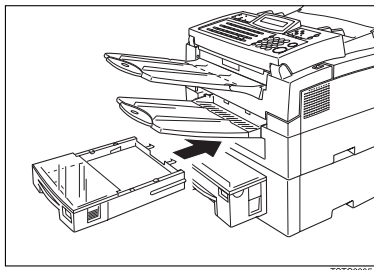

TSTC230E

4

Upper Rear Unit

1 Lift back the document table.

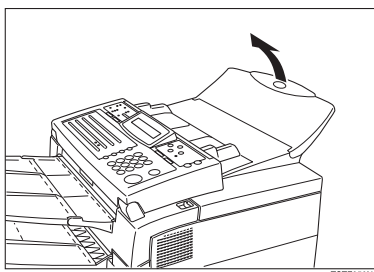

TSTF050N

2 Open the upper rear cover.

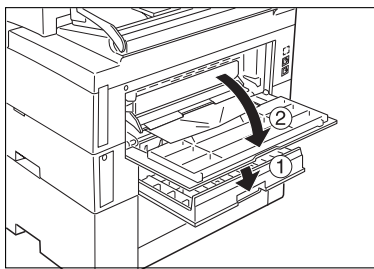

TSTJ120N

3 Pull out any jammed paper.

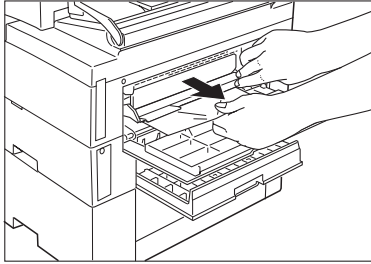

TSTJ110N

4 Close the upper rear cover.

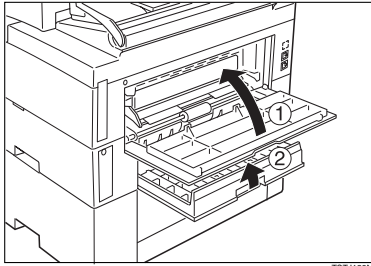

TSTJ130N

4

Troubleshooting

Error Messages

The following messages may appear while you are operating or programming the machine.

CHECK AUTO-DIALING	You cannot use the auto-dialer at the moment. Use the ten key pad or the external telephone.
NO FILE EXISTS	No polling reception operations have been programmed. There are no messages in memory waiting for transmission. Incorrect file number. Check the file number and try again.
4 TOO MANY DEST.	The memory cannot hold any more telephone numbers. Either: <ul style="list-style-type: none"> • Delete some numbers then try again. • Wait until some of the Send Later or other delayed transmissions waiting in memory have been carried out, then try again.
USED AS GROUPDIAL	This Quick Dial key has a Group stored in it.
USED AS PROGRAM	This Quick Dial key has a Keystroke Program stored in it.
USED AS DIAL	This Quick Dial key has a telephone number stored in it.
USED AS GROUP KEY	This Quick Dial key is programmed as Group key.
NOT PROGRAMMED	Either: <ul style="list-style-type: none"> • This Quick Dial key or Speed Dial Code does not contain a number. • This Quick Dial key does not contain a Keystroke Program.
ALREADY PROGRAMMED	Either: <ul style="list-style-type: none"> • This number is already included in this Group. • This OWN NAME/FAX NUMBER has already been stored for use with this feature.
PLEASE SET PAUSE	You must add a pause after your area code when you input your fax terminal's own telephone number.
ADD TONER	The toner cartridge is empty. Install a new cartridge.
CLEAR ORIGINAL	A document is jammed in the feeder.
CLEAR COPY	Paper is jammed in the printer.

Error Messages

CLOSE COVER	A cover is not closed properly. Check that all covers are closed.
UNABLE USE PRINTER	Machine cannot print a list/ file, because the heater is not warm enough or printer is not ready.
SERVICE CALL 	Machine is out of order. Contact your service representative.
USED AS DIAL OPTION	Dial Option feature is set in Quick 29.
◀CHECK PAPER SIZE	The size of the installed paper does not match the currently selected paper size. Set the paper size or install the appropriate paper.
IN USE	This Quick Dial is being used for (e.g., a Send Later Transmission)

Troubleshooting

Solutions to Common Problems

Problem	Required Action
STANDBY MODE	
Nothing happens when the switch is turned on.	Check the power cord. Is it properly plugged into the outlet? Plug it in firmly.
SET DOC. OR DIAL NO. is not displayed.	Switch the power on. If the Power indicator does not light, check that the power cord is plugged in. If the Energy Saver indicator lights, press the Energy Saver key.
<div style="background-color: #444; color: white; padding: 2px 5px; border-radius: 5px; display: inline-block;">4</div> The display does not show the Ready condition, or the machine stops during an operation.	Does CLEAR ORIGINAL or CLEAR COPY appear in the display? Clear the misfed paper.
	 Reference See P.38 "Clearing a Document Jam", P.39 "Clearing a Copy, Fax, or Print Jam".
	Does ADD PAPER appear in the display? Load paper into the paper tray. See P.31 "Loading Paper in the Main Cassette".
	Does CLOSE COVER appear in the display? Close all covers.
	Is the Add Toner indicator on? Load a new toner cassette. See Chapter 9, "Replacing the Toner Cassette and Cleaning Pad" in the Advanced Features manual.
TRANSMISSION	
The original is not pulled into the auto document feeder.	You did not feed the document far enough into the feeder. Insert the document into the feeder until it stops. Retransmit.
	Do user maintenance, especially rollers(1,8). See Chapter 9, "Cleaning the Rollers and Scanner" in the Advanced Features manual.
	The telephone line is disconnected. Check that the line is connected properly.
	The telephone line type setting is incorrect. Check the telephone line type setting. See Chapter 7, "Setting the Phone Line Type (Function 62) in the Advanced Features manual.

Problem	Required Action
The original is not pulled into the auto document feeder.	The dialed number does not contain an PSTN access code or a pause. Include the PSTN access number and a pause before the telephone number.
	The dialed number did not have enough pauses between the access PSTN number and the telephone number. Try adding more pauses after the access PSTN code.
Frequent original misfeeds (Multifeeds)	Incorrect positioning of originals Put the document in the feeder correctly. See P.11 "Memory Transmission".
	Incorrect alignment of originals Align the edges of the document. See P.10 "Suitable Document Types".
	Curled pages Flatten the document. See P.10 "Suitable Document Types".
	Incorrect document type Use a proper document type. See P.10 "Suitable Document Types".
	Mixed document types The pages must all be of the same type.
	Static electricity on the originals Shuffle the document. See P.11 "Memory Transmission".
	User maintenance is needed. Do user maintenance, especially roller (1). See Chapter 9, "Cleaning the Rollers and Scanner" in the Advanced Features manual.
Frequent original misfeeds (Non-feeds)	Copier silicone oil on the originals Wait a few minutes, and then try again.
	Incorrect alignment of originals Align the edges of the document. See P.11 "Memory Transmission".
	Curled pages Flatten the document. See P.10 "Suitable Document Types".
	Incorrect document type Use a proper document type. See P.10 "Suitable Document Types".
	More than 30 pages in the feeder Do not place more than 30 pages in the automatic document feeder at once.
	User maintenance is needed. Do user maintenance, especially rollers (1,8). See Chapter 9, "Cleaning the Rollers and Scanner" in the Advanced Features manual.

Troubleshooting

Problem	Required Action
Transmission cannot take place; CLEAR ORIGINAL appears.	The document is jammed in the feeder. Remove the jammed document. See P.38 "Clearing a Document Jam".
	The document may be longer than the maximum limit (see Chapter 11, "Document and Paper Specifications" in the Advanced Features manual). Make sure that none of your originals exceed this limit.
	Do user maintenance, especially rollers (1,8). See Chapter 9, "Cleaning the Rollers and Scanner" in the Advanced Features manual.
4 Transmission cannot take place. Before taking action, wait until the machine is standby mode, and then press the [Stop] key.	The other machine is out of order. Check the error report. Ask the other party to check their machine and correct the fault.
	The line is noisy. Check that the dial tone is sent out. Try to retransmit.
Consistent difficulty in communicating with a particular terminal	There are some bad lines between you and that other terminal. Store that terminal's number as a Quick Dial Key or Speed Dial Code.
Consistent poor image quality when communicating with a particular terminal	Then call a service representative. Inform the nature of the problem and give the Quick Dial Key or Speed Dial Code that you stored the number in.
RECEPTION	
The telephone keeps ringing and no fax is printed.	You are in TEL mode. Change to FAX mode. See P.17 "Reception Modes".
	Power is switched off. Switch the power on.
RECEPTION/COPYING	
No printout; the Add Paper indicator is lit.	The cassettes are empty. Add Paper . See P.31 "Loading Paper in the Main Cassette".
No printout; CLEAR COPY appears.	The printer has jammed. Clear the jam. See P.39 "Clearing a Copy, Fax, or Print Jam".
Copies are blank.	The original must be placed face down in the document feeder. Position the original correctly. See P.11 "Memory Transmission".

Problem	Required Action
Copy paper misfeeds occur frequently.	Is the proper paper in the paper cassette? Paper size and weight must be within the standards set for this machine.
	Is it folded, wrinkled, damp, or curled paper in the paper cassette? Always use dry, undamaged paper.
	Is the paper set properly in the paper cassette? Always load paper correctly. See P.31 "Loading Paper in the Main Cassette". Make sure that there is not too much paper in the trays; do not fill them up over the load limit mark.
	Are there any pieces of misfed paper or other foreign objects in the machine? Make sure that the paper path is completely clear of paper and other material after a misfeed.
	Are you copying onto recycled paper? Fan the stack of recycled paper and load it in the paper tray.
Stripes on copies.	The scanner is dirty. Clean the scanner (6). See Chapter 9, "Cleaning the Rollers and Scanner" in the Advanced Features manual.
TELEPHONING	
You cannot receive phone calls; the unit only rings once then goes into receive mode.	You are in FAX mode. Change to TEL mode. See P.17 "Reception Modes".
You cannot receive phone calls; the unit does not ring.	The telephone line is not connected. Connect the modular cord. See Chapter 10, "Connecting Up to the Telephone Line" in the Advanced Features manual.

INDEX

A

- Add Paper indicator, 5
- Add Toner indicator, 5
- Arrow keys, 5
- Auto Mode, 17

C

- Canceling a Memory Transmission, 14
 - Before start is pressed*, 14
 - During Transmission*, 14
 - While the document is being scanned in*, 14
 - While the message is awaiting transmission (Functions 21)*, 14
- Canceling an Immediate Transmission, 15
 - Before start is pressed*, 15
 - While dialing or during transmission*, 15
- Characters, 29
- Check Display indicator, 5
- CLEAR COPY, 39
- Clearing a Jam
 - Cassette Entrance*, 41
 - Document*, 38
 - inside the machine*, 39
 - inside the Main Machine*, 39
 - Upper Rear Unit*, 42
- Clear key, 6
- Communication Problems, 37
- Control Panel Display, 5
- Copy key, 6
- CSI → FAX NUMBER, 19

D

- Document Delivery Tray, 3
- Document Guide, 4
- Document Jam, 38
- Document Table, 4

E

- Editing
 - Fax Numbers*, 22
 - Group*, 25
 - Quick Dial Numbers*, 22
 - Speed Dial Numbers*, 23
- Energy Saver key, 6
- Entering
 - Characters*, 29
 - Symbols*, 29
- Erasing
 - Group*, 27
 - Quick Dial Numbers*, 22
 - Speed Dial Numbers*, 23
- Error Messages, 44

F

- FAX HEADER, 19
- Faxing, 9
- Fax mode, 17
- FAX NUMBER, 19
- Front Cover, 4
- Front Cover Release Lever, 4
- Function key, 6

G

- Group Dial List, 26
- Group Key, 28

H

- Handset, 4

I

- Immediate Transmission, 15
- Indicators
 - Add Paper*, 5
 - Add Toner*, 5
 - Check Display*, 5, 36
 - Manual Receive*, 6, 17
 - Memory*, 5
 - Receive File*, 5, 36
- Initial Settings, 19
- Introduction, 3

M

- Main Paper Cassette, 3
- Main switch, 4
- Manual Receive indicator, 6, 17
- Memory indicator, 5
- Memory Transmission, 11
- Multi-purpose Feeder, 4

O

- On Hook Dial key, 6
- Operation Panel, 4, 5
- OWN NAME, 19
- Own number, 19

P

- Paper, 31
- Part Names, 3
- Pause/AI Redial key, 5
- Print Delivery Tray, 3
- Programming
 - FAX HEADER, 19
 - FAX NUMBER, 19
 - Fax Numbers, 22
 - Group, 25
 - Group key, 28
 - OWN NAME, 19
 - Own number, 19
 - Quick Dial Numbers, 22
 - Speed Dial Numbers, 23

Q

- Quick Dial, 22
- Quick Dial Label, 23

R

- Receive File indicator, 5
- Reception Mode
 - Fax Mode, 17
 - Telephone Mode, 17
- Reception Mode key, 6
- Reports
 - Speed Dial List, 23
- Resolution, 16
- Resolution key, 5
- RTI → OWN NAME, 19

S

- Second Paper Cassette, 3
- Sending a Fax, 11
- Solutions to Common Problems, 46
- Speed Dial, 23
- Speed Dial/Tel Directory key, 5
- Start key, 6
- Stop key, 6
- Suitable Document Type, 10
- Symbols, 7

T

- Telephone mode, 17
- Ten key pad, 6
- Transmission
 - Immediate, 15
 - Memory, 11
- Troubleshooting, 31
- TTI → FAX HEADER, 19

U

- User Function keys, 6

V

- Volume Control, 34

W

- Wild Cards, 29

